

# OUTLINE DIMENSIONAL DRAWING

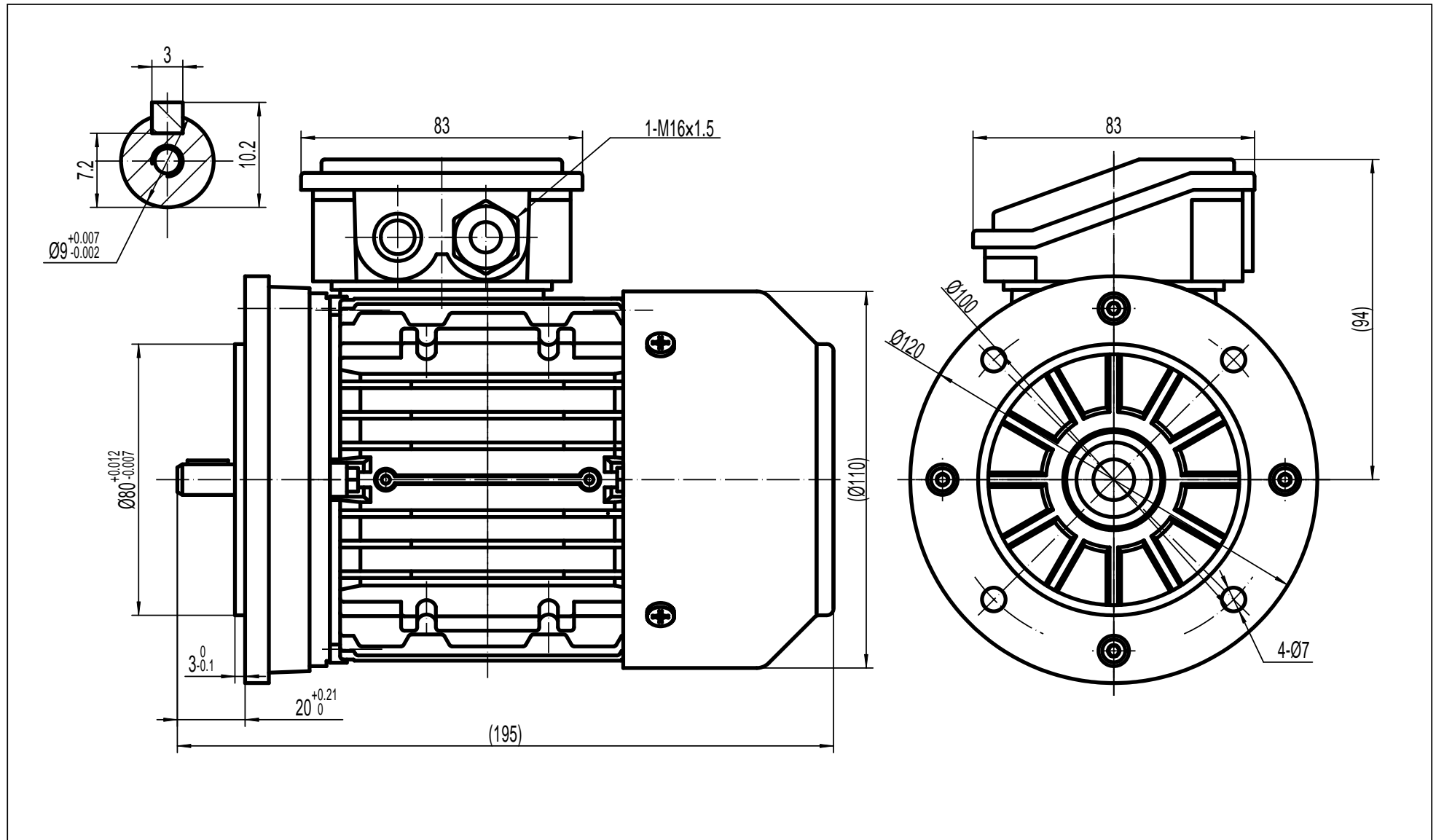

TECHTOP AUSTRALIA PTY LTD	
FRAME	TAI 56A B5
DATE	RAWING NO.
2011/10/14	1ST080.055.001-011 A