

OUTLINE DIMENSIONAL DRAWING

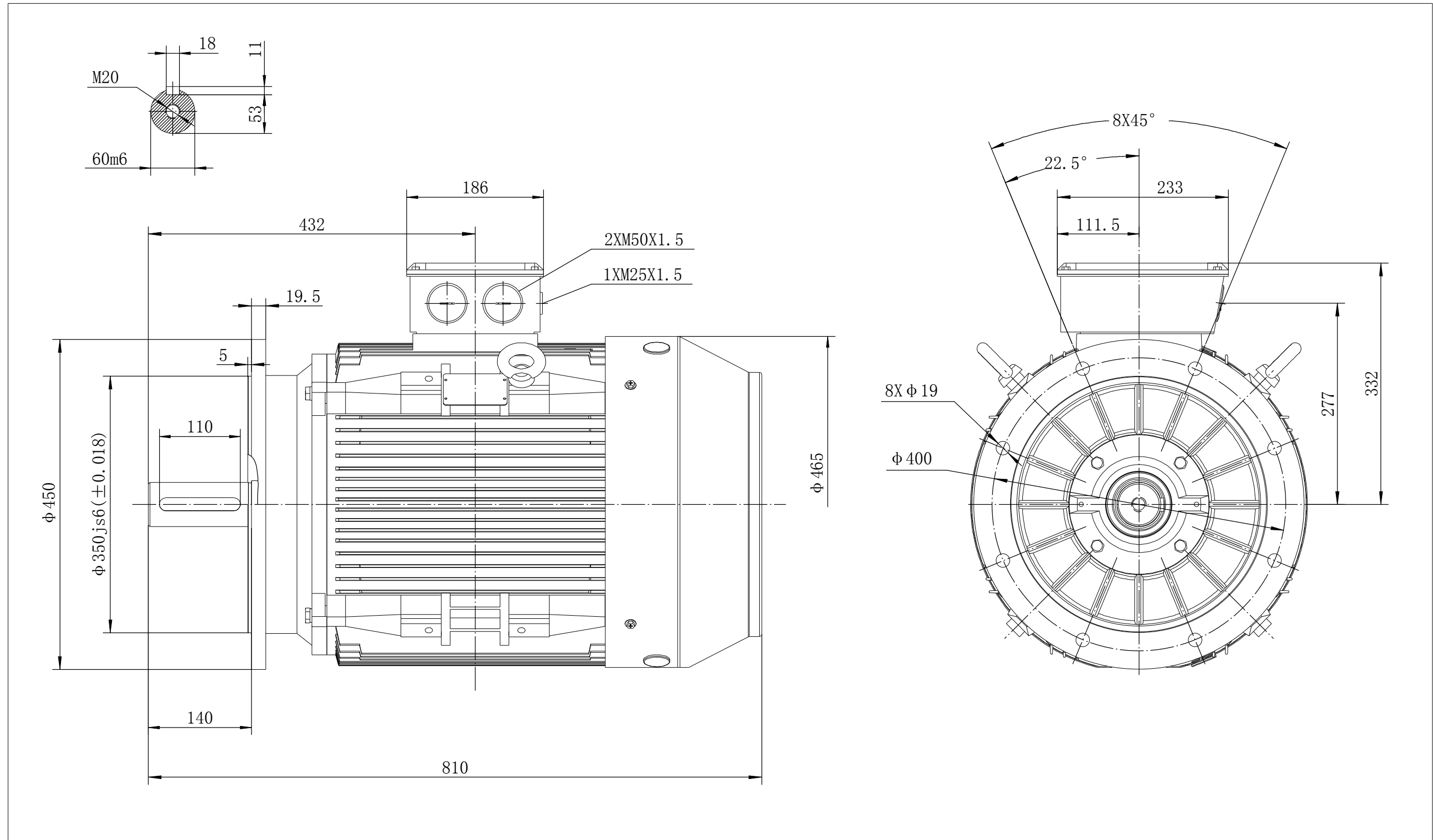

TECHTOP AUSTRALIA PTY LTD	
FRAME	TCI 225S-4.6.8P B5
DATE	DRAWING NO.
2012/05/10	1HMY.010.T068B