

# OUTLINE DIMENSIONAL DRAWING

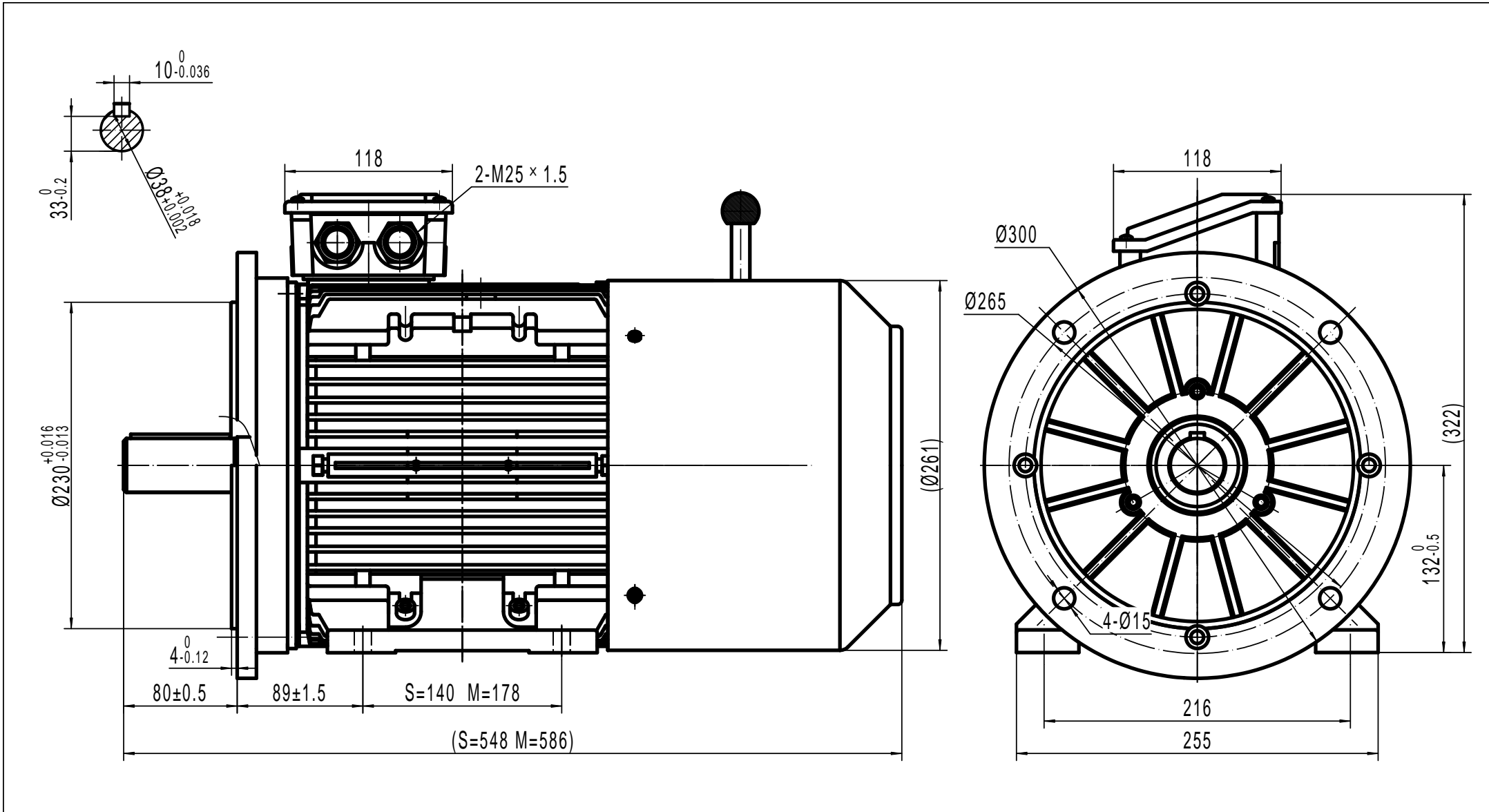

TECHTOP AUSTRALIA PTY LTD	
FRAME	TAIB 132A B35
DATE	DRAWING NO.
2013/10/22	1ST106.051.001-024 A