

OUTLINE DIMENSIONAL DRAWING

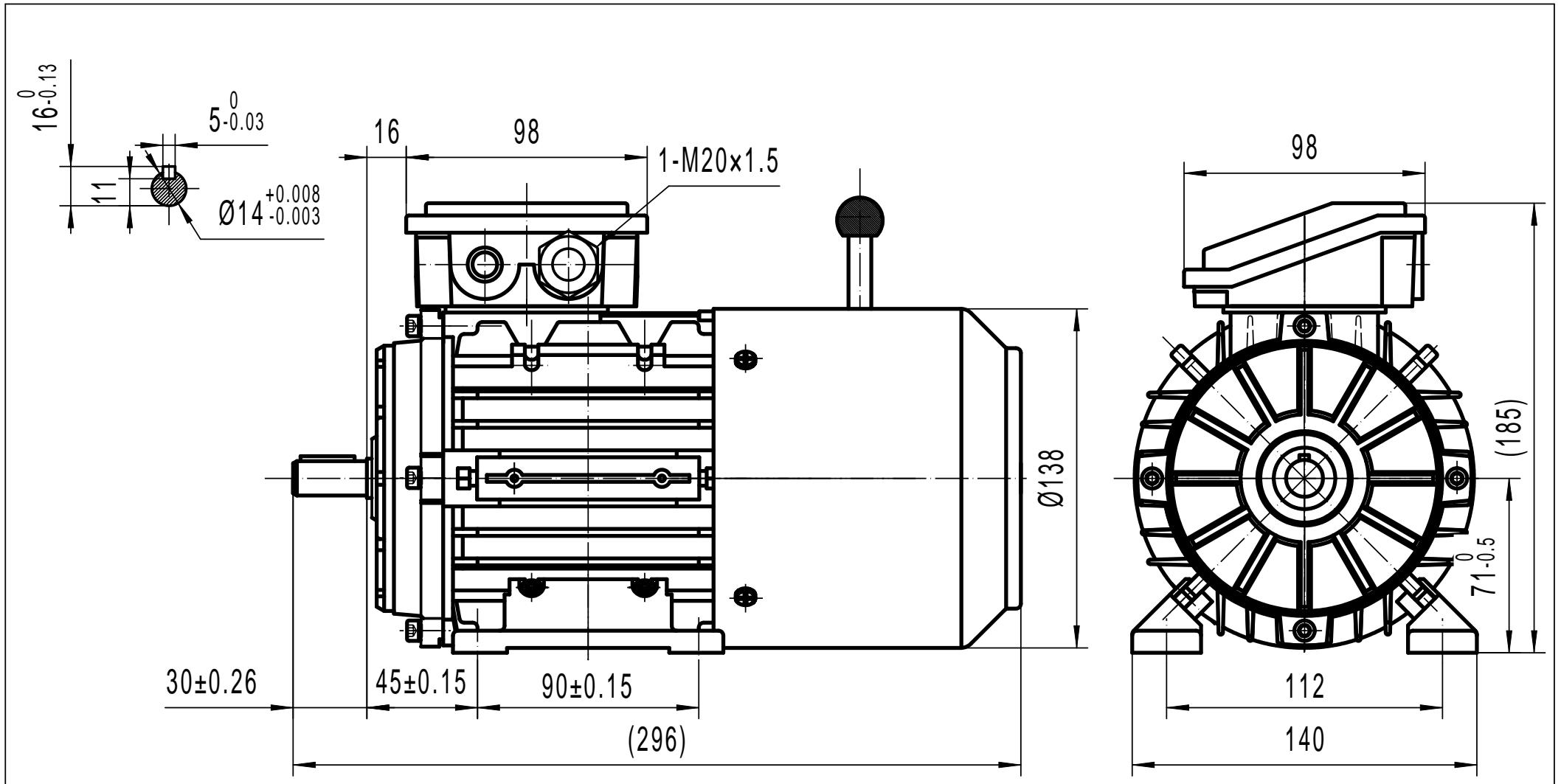

TECHTOP AUSTRALIA PTY LTD	
FRAME	TAIB 71A B3
DATE	DRAWING NO.
2013/10/22	1ST101.050.001-010 A