

OUTLINE DIMENSIONAL DRAWING

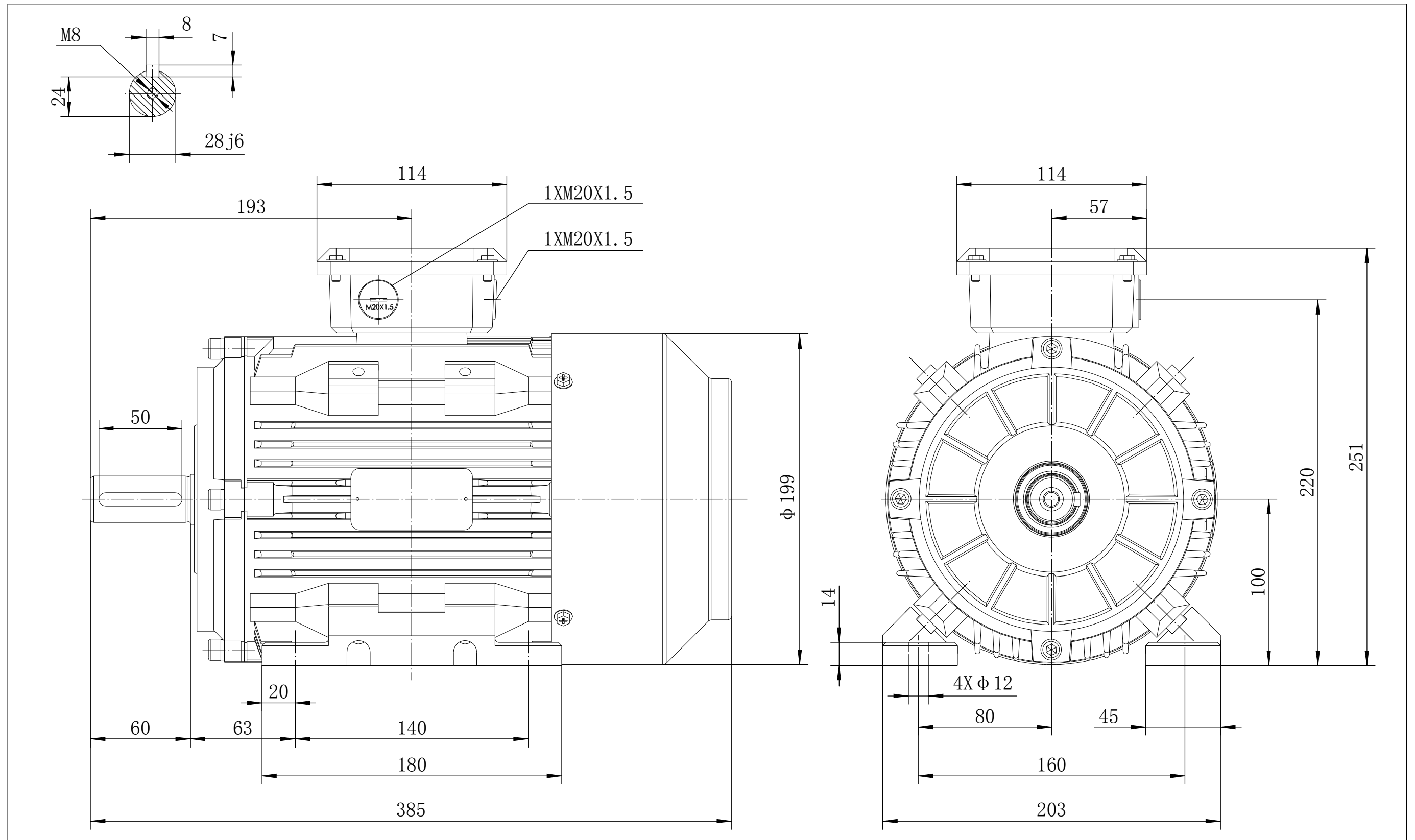

TECHTOP AUSTRALIA PTY LTD	
FRAME	TCI 100L B3
DATE	DRAWING NO.
2012/05/10	1HMY.010.T019B