

OUTLINE DIMENSIONAL DRAWING

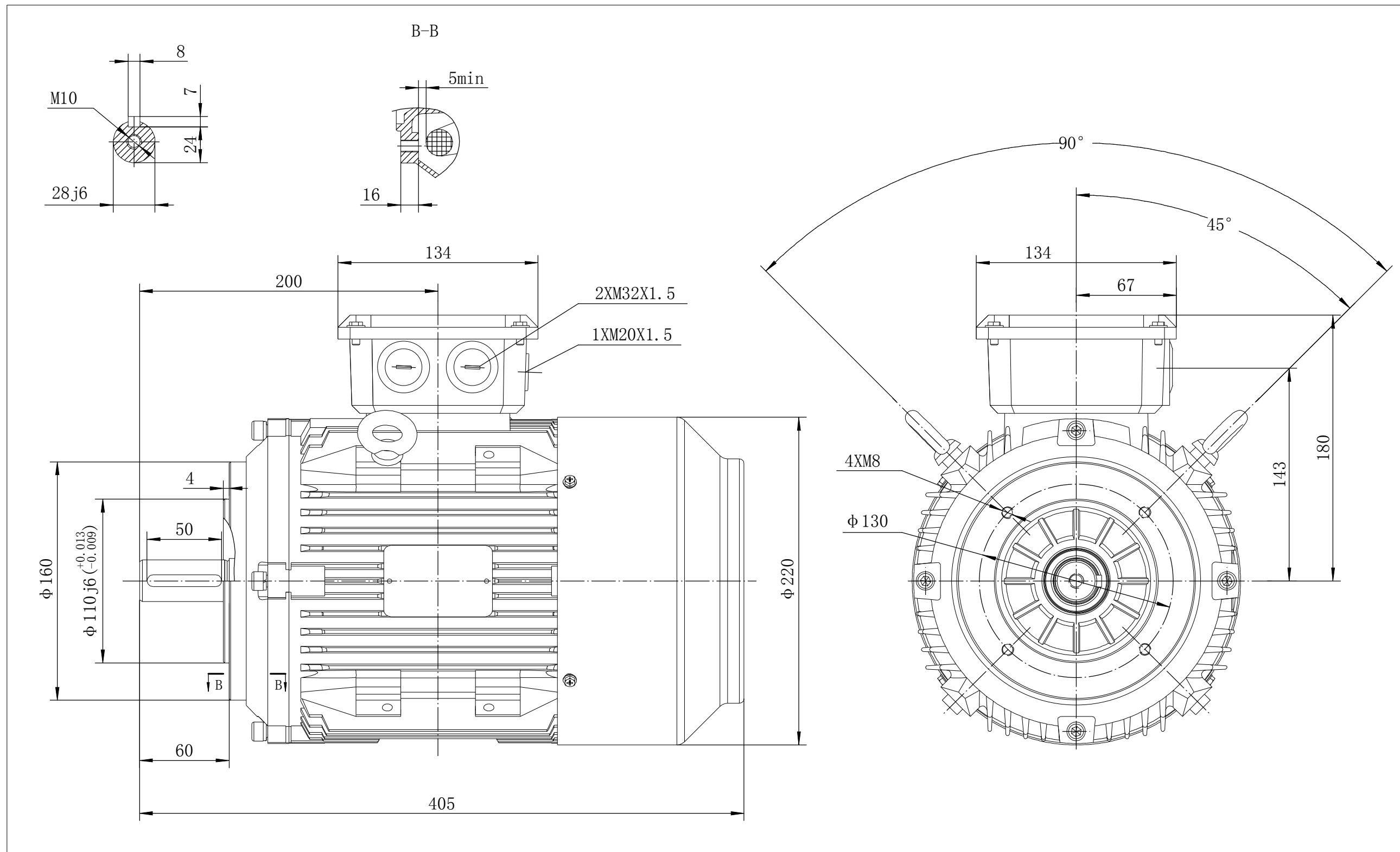

TECHTOP AUSTRALIA PTY LTD	
FRAME	TCI 112M B14
DATE	DRAWING NO.
2012/05/10	1HMY.010.T027B